

# Speed Gate



## TS - H8008 Speed Gate With Swing Panels

The TS-H8008 speed gate with swing panels is designed in a modern and elegant style and provides an ideal contactless solution for access control at sites with high aesthetic and comfort requirements.

# Introduction

- **TS-H8008 speed gate** was developed to be robust, reliable and esthetically pleasing. Its rounded lines house a sturdy blocking mechanism designed for very low maintenance. The equipment is provided with a standard electric interface and is easily integrated into a system with read facilities.
- **TS-H8008 speed gate** adopts latest electromechanical integration technology, is designed for pedestrian passage control at entrance points of administrative buildings, banks, shops, ports, railway terminals, airports, etc.
- Equipped with high processing capacity and an exclusive detection system, the **TS-H8008 speed gate** guarantees accurate user tracking and prevents any unauthorised use.



## EXAMPLES OF CONTROL UNITS\*



# Technical Specifications

## Framework Specifications

Standard housing	Brushed SS AISI 304
Available housing	Brushed SS AISI 316 / Polished SS AISI 304 Polished SS AISI 316 / Powder coated RAL
Dimensions (WxLxH)	1600x160x1060 mm
Top lid	Stainless steel top Acrylic top
Swing Panels Material	12mm Tempered glass 10mm Organic glass
Swing panels length	260~550mm
Passage width	600 mm ~ 900 mm

## Electric Specifications

Voltage	AC (100–240) V, 50/60 Hz
Power consumption	80W (Standby)
Mechanism	Motorized
Motor	DC Servo motor
Core	ARM--M4/32 bits CPU
Locate mode	Incremental encoder accurately positions 2,500 lines
Electromotor Control Mode	High performance DSP chip
In-built intrusion sensor	9 pair/lane
Opening/Closing Speed	0.35 ~ 1 sec (adjustable)
Throughput rate (in the single passage model)	40 persons/min
MCBF	5 million cycles
Communications port	TCP/IP \ Rs232 \ Rs485 \ CAN \ I/O
Input port	Relay dry contact signal, +12V level signal, pulse width >100ms, DC12V pulse signal, RS485
Passage directions operation model	Single or Bi-directional available
Temperature range	from -15 °C to 75°C
IP code	IP43
Noise level	Standby < 45db(A), Running>55db(A)
Working Environment	indoor or outdoor (with canopy)
Relative humidity	5% ~ 90% not condensed
Warranty period	one year from the date of sale of the product

## Warning Status

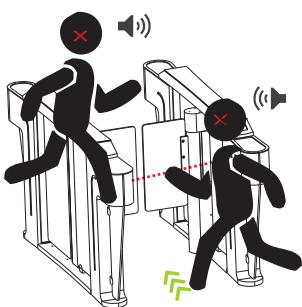

Anti unauthorised

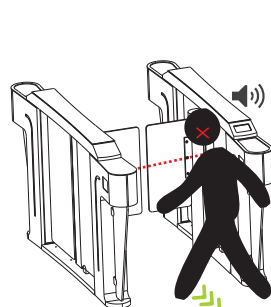

Anti-reverse



Anti-tailgating

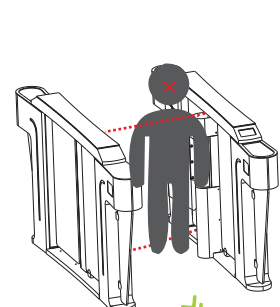

Anti-occupied

# Functions & Features

## Operation Models

with 9 different operation modes available, single/bi-directional controlled, free passage, normally open, normally close etc, meeting multiple needs of users.

## Secondary Open

Lane close when there is illegal intrusion or reverse intrusion, and would open when the lane is cleared, protecting the right of the authorized access. (This function can be applied to places need strict access control like stations and scenic spots etc)

## Audible Alerts

The device detects illegal behaviors, such as illegal intrusion, reverse intrusion, overtime occupied, and gives out different sounds alarms specifically to draw attention from the secure.

## Logical Detection

Equipped with 9-12 pairs of infrared sensors (can be added to 24pairs or replaced with light curtains), the tracking system can detect exact position of users and items in real-time, and also can monitor the authorized access, giving out alarms through sound/light or closing the door if there are any illegal access.

## Indication Modules

Indication modules of the passage grant/denial are located in the user line-of-sight range on the speed gate central post allowing quick passage completion.

## Fail Safe

Free passage on power failure, meeting the requirement of fire control passage, so that swing panel unlocked control may be realized in emergency for.

## Fault Self-detection

System can self-detect errors all the time, and displays the results on the internal display and upper computer, more intelligent and convenient.

## Parameters Settings

The parameters of the device can be setup conveniently through the LCD on the speed gate central post and upper computer.

## Status Feedback

Providing multiple feedbacks of running status to meet the diverse needs of users. (reflect different device running status according to the requirements of users)

## Emergency exit

When power failure or fire alarm, gates will open automatically, which is complying with fire safety requirements.

## Anti-collision

The gate is locked automatically to withstand forced entry attempts.

## Auto-reset

Access would be denied exceed the stipulated time.

## Anti-pinching

with 9 different operation modes available, single/bi-directional controlled, free passage, normally open, normally close etc, meeting multiple needs of users.

## Tailgate Detection

Assures that only one person enters for each authorized credential. Prevents "Piggybacking" by unauthorized persons.

## Card Stacking

Lane remains open while authorizing multiple credentials(bi-directional).Maximum stacking times: 255.

# Advantages

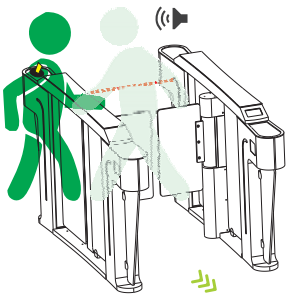

The lane would only open, when the lane is cleared.

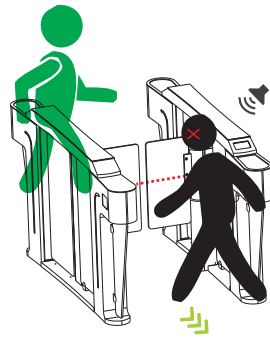

The lane would close when there is reverse intrusion, and open secondary when the lane is cleared.

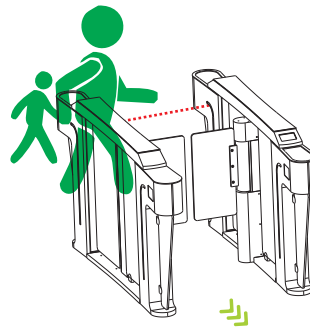

Detecting simultaneous passage of parents carrying child

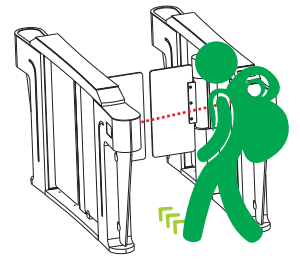

Piggybacking Detection

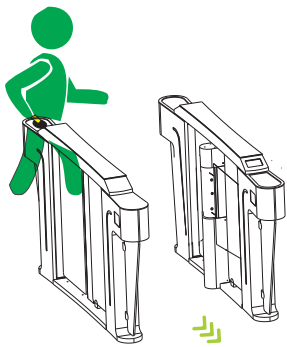

The red color indicator light shows blocked traffic direction. The green color shows unblocked traffic direction



IR beams monitor the length of the pedestal to ensure the lane is clear before the barrier attempts to close.

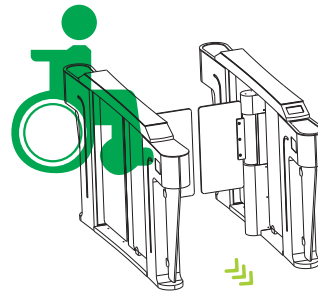

Disability discrimination  
Lane widths can vary to accommodate ADA compliance (without anti-tailgating)

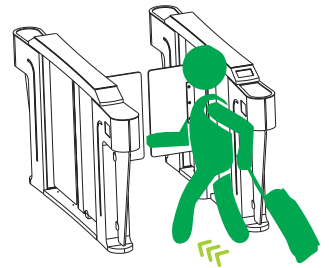

Luggage detection

## Throughput

- ▶ Fast opening/closing of swing doors (<1 sec.);
- ▶ Precise pictograms for intuitive use;

## Security

- ▶ High-performance detection system regards of obstacle height;
- ▶ Glass obstacles up to 1500 mm;
- ▶ Electromechanical locking to withstand forced entry attempts;

## Reliability

- ▶ Highly reliable products with MCBF of several million cycles;
- ▶ Very low cost of ownership;

## Connectivity

- ▶ It can be integrated with any kind of access controller system (e.g.: RFID device, Push button, Fingerprint and Biometric device etc);
- ▶ Optional console device can remotely monitor and control lane usage modes;

## Aesthetics

- ▶ Transparent and elegant design;
- ▶ Minimal footprint for maximum throughput;
- ▶ Discreetly and ergonomically integrated card reader;
- ▶ Precision controlled tempered glass obstacles;
- ▶ Top quality assembly and finish;

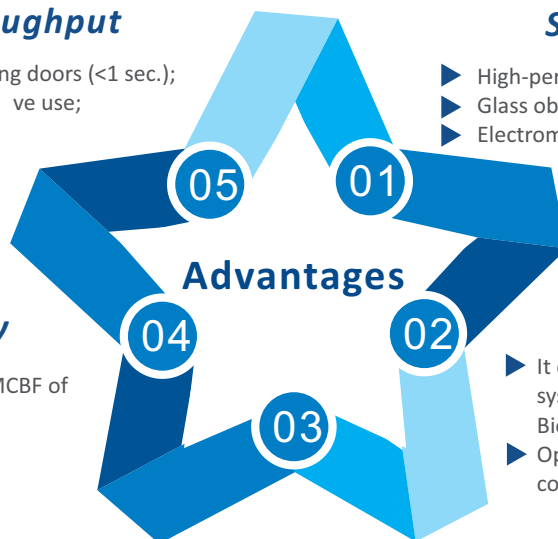

## Dimensions (unit: mm)

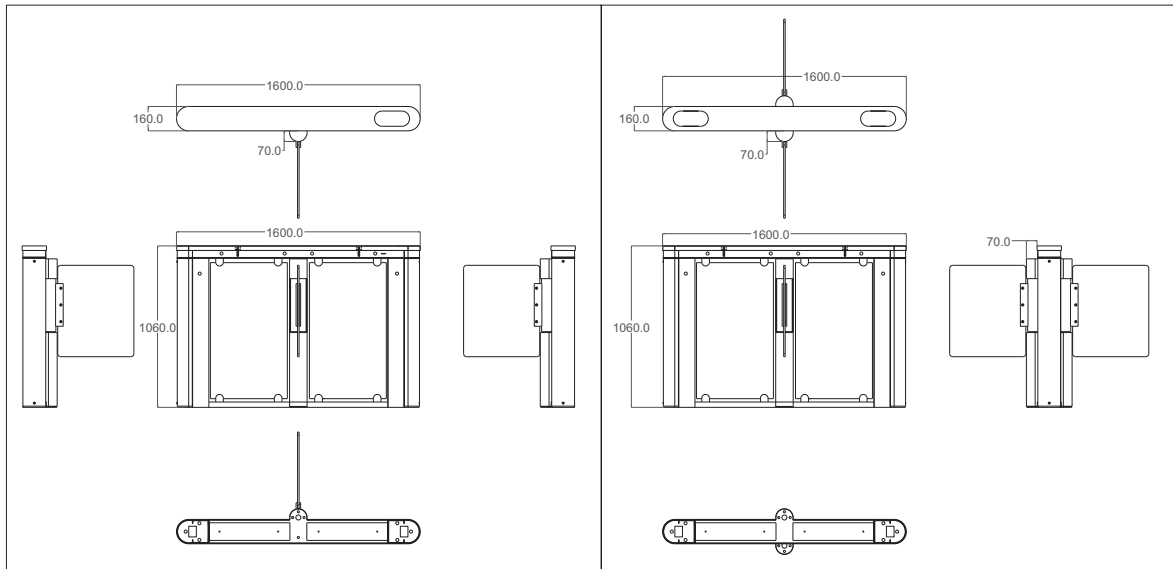

### Normally Open

The device swing panels are open until the moment of unauthorized individual passage attempt. This operation mode is generally used for occasions with large traffic flow or concentrated traffic.

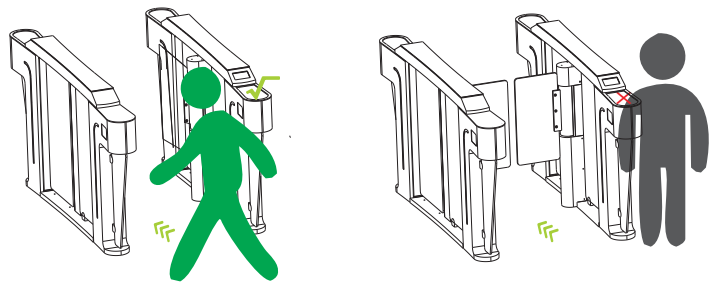

### Normally Closed

The device swing panels are closed till the moment of signal receiving from the external control unit (e.g. card reader), after receiving the valid signal, the swing panels will close after the individual passageway detection.

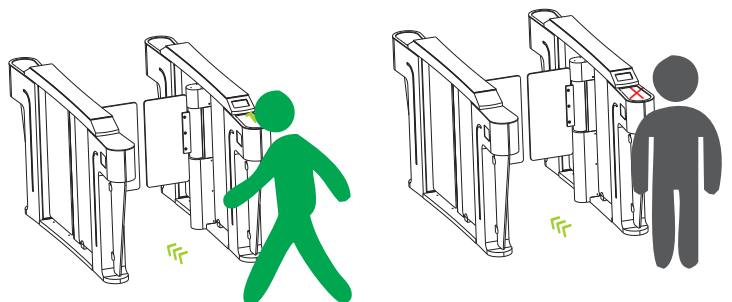

### Free Passage

The device swing panels keep opening, cancel limit control, increasing the throughput during busy periods.

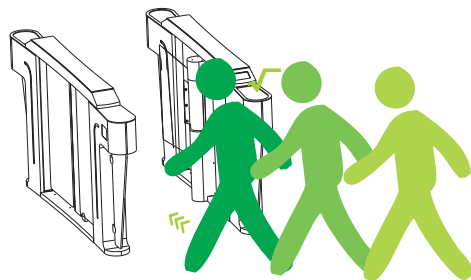

# Extended & Customized

## Hardware

- ▶ Alternative Materials, Finishes and Custom Design;
- ▶ Alternative imported motor or direct drive motor;
- ▶ Alternative extended 24 pairs sensors or light curtain;

## Passage Width

- ▶ There are several swing panel models, which can be chosen according to the passageway width and to the operation peculiarities upon making an order.
- ▶ Lane widths can vary to accommodate ADA compliance (without anti-tailgating)

## Materials

- ▶ Housing: alternative AISI 316 Stainless Steel;
- ▶ Swing Panel: Alternative tempered glass, different color acrylic or polycarbonate etc;

## System

- ▶ Customize non-standard application according to the needs of users
- ▶ Customize communication protocol

## Functions

- ▶ LED counter function optional
- ▶ Camera system integration
- ▶ Reader integration

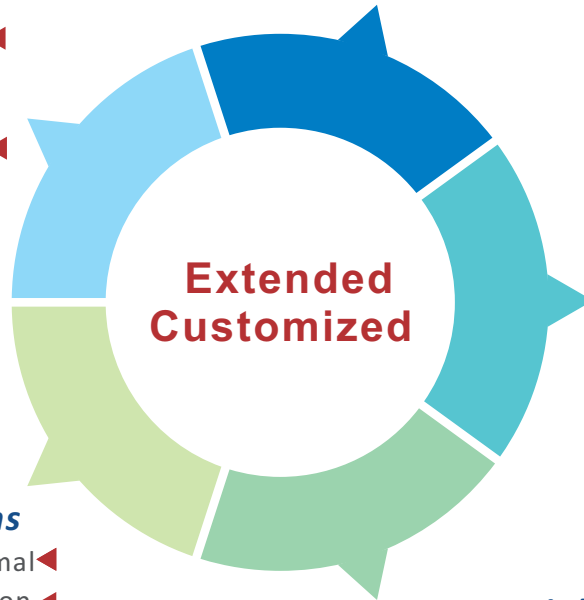

**Extended  
Customized**



17-6-1 14:11