

High Speed Door Servo Control System

Contents

Introduction.....	3
Inspection.....	4
General Characteristic.....	4
General Appearance.....	4
Specifications.....	5
1. Specifications for Motor.....	6
2. Specifications for Electronic Control System.....	7
Operating Instructions.....	8
1. Basic Function.....	8
2. Control Key/Button.....	8
3. Install the stroke controller.....	9
4. Safety.....	9
Maintenance.....	10
Size.....	10
System Operation.....	12
Erro Table.....	19
Port Table.....	20

Introduction

Thank you for choosing our High Speed Door Servo Control System.

Please read this manual carefully before you start to use the system. In this manual you will find instructions for how to set the operating the control unit, malfunction diagnostics and debugging, and routine maintenance.

Notice:

- Before connecting the system to live wire place make sure the power supply is off.
- Please make sure the power voltage in the main circuit is the same as controller's rated voltage. Also please make sure the ground terminal is properly and reliably connect to the ground wire.
- DO NOT touch output terminal directly. DO NOT short circuit the output terminal and out shell.
- After the power supply is cut, and before the LCD is off, there still high voltage electricity in the circuit, so DO NOT touch the internal wiring and electronic components.
- Internal wiring and electronic components are very sensitivity to static electricity, so DO NOT let any object contact the internal wiring and electronic components of motor driver and the main circuit of the touch control panel.

Inspection

All product has passed inspection before is leaving the factory.

When you open the box place make sure there is no damager during shipping.

Also to confirm the equipment ratings are matching your requirement.

General Characteristic

Our servo control system is suitable for high speed PVC and aluminum doors.

The system is in compact package, with high torque and high operating speed, lower noise, high reliability, smooth and soft operating curves, it's suitable for high speed and intensive usage environment.

The rolling curtain can be controlled by wall switch, push button, bluetooth, ground radar, ground magnetic sensors, etc.

Operating Speed: 0.5m/s-1.5m/s; Operating Width: < 16 m² / ; < 32 m² Daily
operating time: 2000 time; Rated voltage: 220v; Rated Powever: 0.75 KW /
1.5KW

General Appearance



Control Box and Motor

Specifications

Specifications for Motor

Rated Powever	750W	1500w
Speed	2,000 rpm	2,500 rpm
Rated Torque	50 Nm	100 Nm
Motor Thermal Rise	< 30°C	< 30°C
Working Temperature	-35°C-60°C	-35°C-60°C
Torque Management System	Automatic Torque	Automatic Torque
Maximum Door Size	< 16 m ²	< 30 m ²
Limit Switch	Absolute Encoder	Absolute Encoder
Self Locking	Electro Mechanical Brake	Electro Mechanical Brake
Manual Release	Hand Crank	Hand Crank
Weight	10 KG	13.5 KG

Specification for Electronic Control System

Rated Power Supply	AC 220±10%
Rated Voltage	220 v
Speed Control	Closed Loop Speed Control
Position Control	Closed Loop Position Control
Protective Function	Over-current Protection, Over-voltage Protection Under-voltage Protection, Overheating Protection and Overloading Protection
Installation Site	Indoor, away form direct sunlight, dust, corrosive gas, oil and water vapor ect.
Operating Temperature Range	-35°C~60°C
Weight	7.5 KG
Installation Method	Wall Mounted

Operating Instructions

1. Basic Function

The system can be operated via: 1) control box; 2) inching electronic control; 3) continuous automatic operation; 4) emergency stop; 5) single side operation box; 6) time delay; 7) ground radar and/or magnetic sensors. Please refer to Wiring Terminal for external connections.

System has fuse/safety wire shutdown switch for three-phase power protection, fuse/safety wire for operating circuit protection, and temperature sensing relay for motor protection.

2. Control Key/Button

- a) “↑” Key/Button: Inching control door’s opening movement or continuous automatic opening.
- b) “↓” Key/Button: Inching control door’s closing movement or continuous automatic closing.

NOTE: these settings are set according to the contact; however they can be changed according to operating needs.

- c) “STOP” Key/Button: Push this key under emergency situation it will shutdown the operation and the door will stop and stay at that position
- d) Four keys on LCD are main menu keys.

3. Install the Stroke Controller

Stroke Controller utilizes absolute value encoder. Connect the absolute value encoder and reducer via encoder's axle, and fix the wings on to the reducer, than insert the aviation plug into plug receptacle.

4. Safety

- 1) The motor and control box **MUST** ground properly;
- 2) During the installation, commission and operation **NO ONE** is permit to stand under the door and stand in the operating path;
- 3) While installing and testing the motor package, at least half of the door's axle **MUST** be insert into the reducer.
- 4) Check if there any obstacles in the operating path, if there is please remove the obstacles before lower the gate.
- 5) **DO NOT** disassemble the control box; any damagers due to this action are **NOT** cover under free warranty.

The company reserves the right to modify the product, according to improvement of technology and production process, while the basic characteristic of the product may remain some.

Maintenance

The mounting screw for the control box must inspect regularly to prevent screw been getting loose and falling off. Check the internal and external wirings. Check and change the oil for the redactor on regular basis.

Size

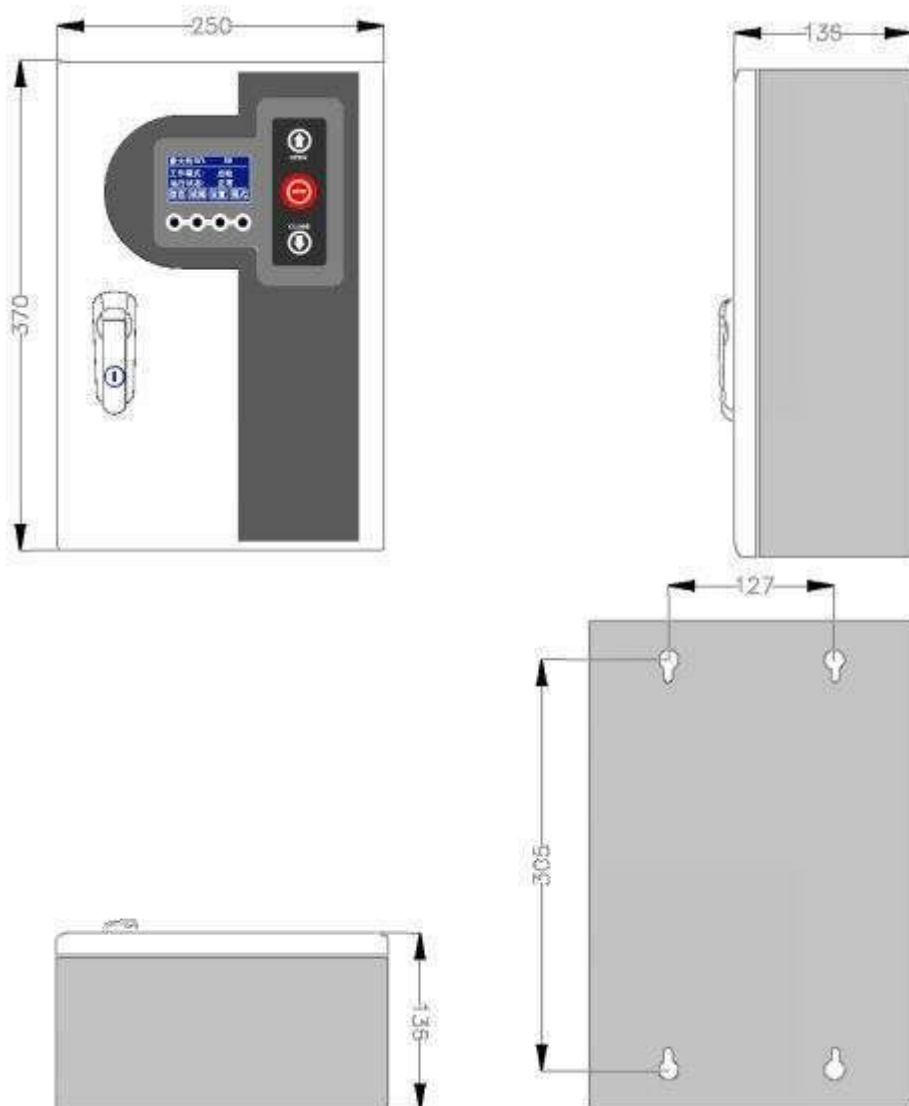

Control Box

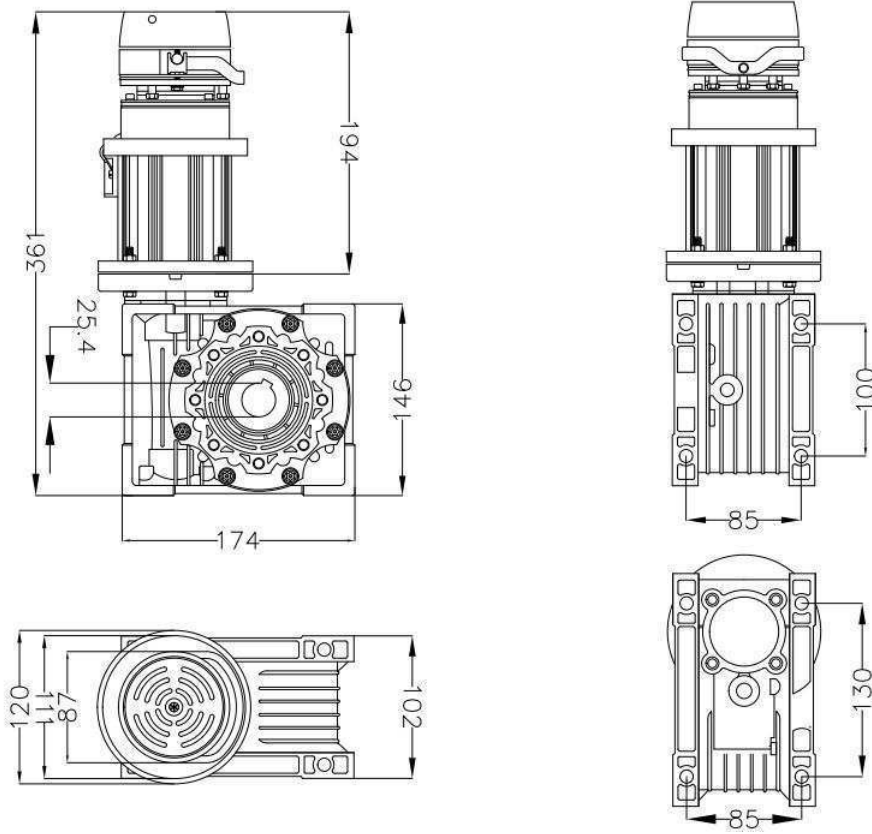

Motor

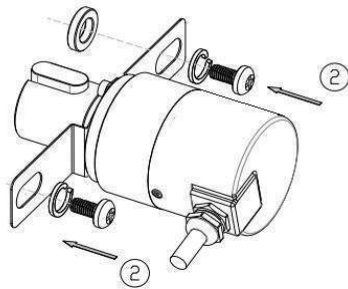
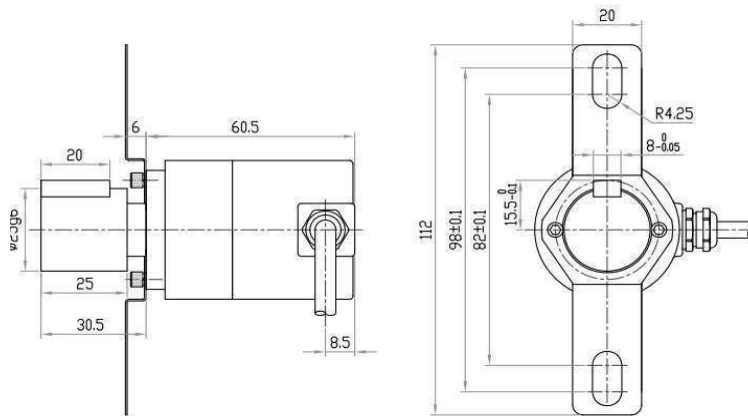

Absolute Encoder

system operation

MAIN-----

(status) : OK、Opening、Closing、Falut、 Stop、 Safty1、 Safty2、 Lock、 Maintenance.

(dispaly) : Torque、 Speed、 Position.

Mode

Press **Mode** key to change the operation mode, manual、 auto、 Jog.

Set

Press **Set** key, input password (6668) 。

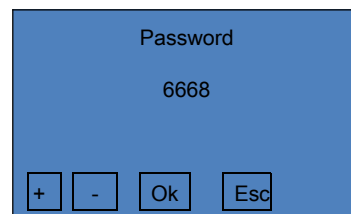
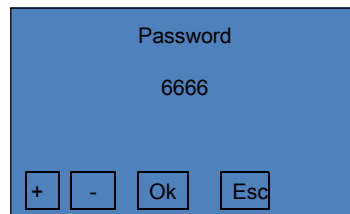

-----1.Parameter 750W

Index	Parameter	Value	Default
1	Opening Speed	10-100	90
2	Closing Speed	10-100	80
3	Open Slowdown dis.	30-70	50
4	Close Slowdown dis.	30-70	50
5	Auto Closing Time	<ul style="list-style-type: none"> •Disable •1-120s 	5
6	Output 1 Config	<ul style="list-style-type: none"> •Non-close Limit •Close Limit •Non-open Limit •Open Limit •Opening •Closing •Non-limit Position •Limit Position •Reach Close Limit 	Non-close Limit (Lock output)
7	Output 2 Config	<ul style="list-style-type: none"> •Non-close Limit •Close Limit •Non-open Limit •Open Limit •Opening •Closing •Non-limit Position •Limit Position •Reach Close Limit 	Reach Close Limit
8	Partial Opening	10-100%	100
9	Display Config	<ul style="list-style-type: none"> •Position •Speed •Torque 	Torque
10	Backlight Setting	<ul style="list-style-type: none"> •60s Off •Always On 	60s Off

1. Parameter 1500W

Index	Parameter	Value	Default
1	Opening Speed	10-100	125
2	Closing Speed	10-100	125
3	Open Slowdown dis.	30-70	50
4	Close Slowdown dis.	30-70	50
5	Auto Closing Time	<ul style="list-style-type: none"> ● Disable ● 1-120s 	5
6	Output 1 Config	<ul style="list-style-type: none"> ● Non-close Limit ● Close Limit ● Non-open Limit ● Open Limit ● Opening ● Closing ● Non-limit Position ● Limit Position ● Reach Close Limit ● Err ● Disable 	Disable
7	Output 2 Config	Refer to Output 1 Config	Disable
8	Output 3 Config	Refer to Output 1 Config	Disable
9	Output 4 Config	Refer to Output 1 Config	Disable
10	Partial Opening	10-100%	100
11	Display Config	<ul style="list-style-type: none"> ● Position ● Speed ● Torque 	Torque
12	Backlight Setting	<ul style="list-style-type: none"> ● 60s Off ● Always On 	Always On
13	Anti-frozen running	<ul style="list-style-type: none"> ● Disable ● 1-999 min 	Disable

-----2.Limit Switch Setting

Press **Ok** key to set limit switch.

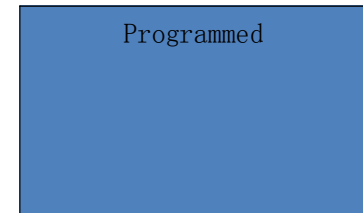
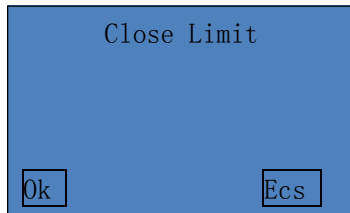
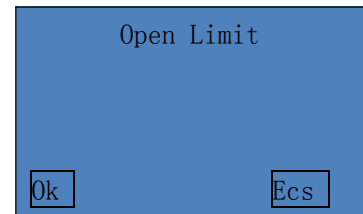
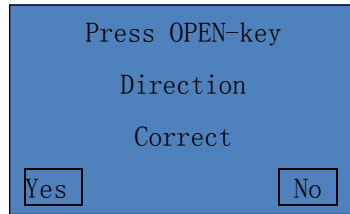

-----3.RTC Config

-----4.Advanced Setting

-----1.Communication

Set RS485 slave address and band rate.

-----2.Contact Type

Index	Parameter	Value	Default
1	Ext E-Stop(12)	N.O/N.C	N.O
2	Safety1(15)	N.O/N.C	N.O
3	Safety2(16)	N.O/N.C	N.O
4	Auto Open(17)	N.O/N.C	N.O
5	Partial Open(18)	N.O/N.C	N.O
6	Start(20)	N.O/N.C	N.O
7	Open Limit(21)	N.O/N.C	N.O
8	Close Limit(22)	N.O/N.C	N.O
9	Lock Input(23)	N.O/N.C	N.O

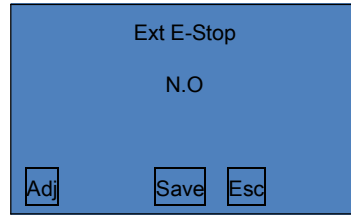
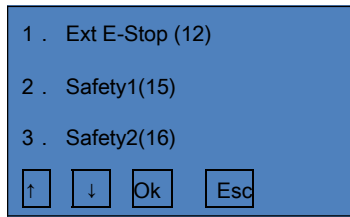

-----3.Adv Parameter

First, input password (7779) 。

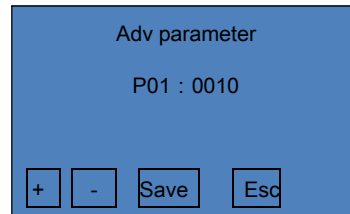
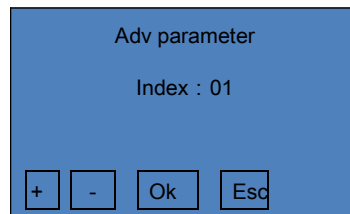
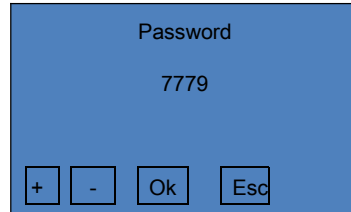
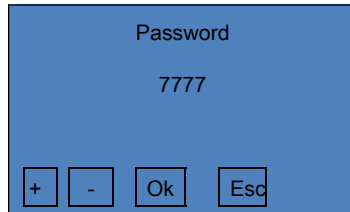

-----4. Maintenance

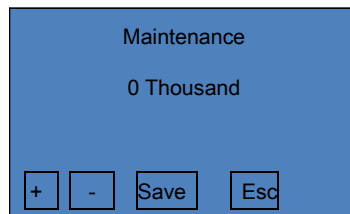

-----5.System Config

Password
0000

← → Ok Esc

1 . Cycle
2 . Time
3 . Password

↑ ↓ Ok Esc

Work Cycle
0 Thousand

+ - Save Esc

Work Time
0 Days

+ - Save Esc

Password
1111

→ Adj Save Esc

-----6.Auto Test

Auto Test
(display)
0

On Off

-----5.Language

Language
English

Adj Save Esc

-----6.Default

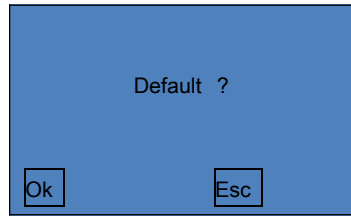

-----Info

-----1.Input Query

Displays the current status of each port , 1: signal, 0: No signal.

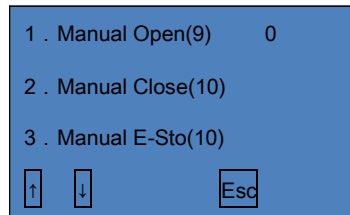

Index	Port	Status
1	Manual Open(9)	0 : No Signal 1 : Signal
2	Manual Close(10)	
3	Manual E-Stop(11)	
4	Ext E-Stop(12)	
5	Safety1(15)	
6	Safety2(16)	
7	Auto Open(17)	
8	Partial Open(18)	
9	Start(20)	
10	Open Limit(21)	
11	Close Limit(22)	
12	Lock Input(23)	

-----2.Sum Counter

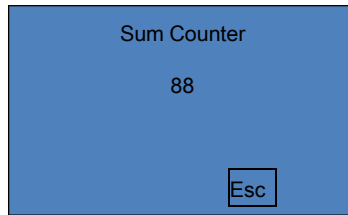

-----3.Maint Counter

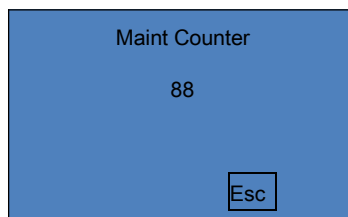

-----4.Fault Memory

Query the recent 30 times the information of failure.

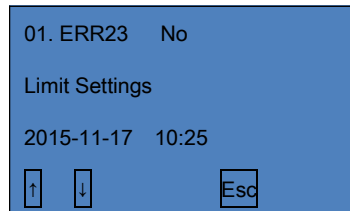

-----5.System Query

-----6.Version

-----7.RTC Query

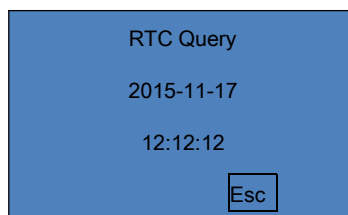

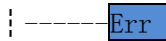

Show the fault occurs, some of the fault will be automatically reset, can be in the history of the fault.

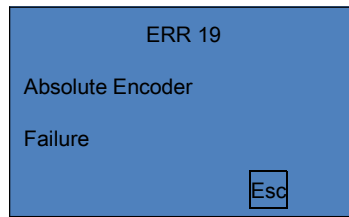

Erro Table

Err Code	Content
ERR01	Overflow
ERR03	Under Voltage
ERR04	Over Voltage
ERR05	Over Voltage
ERR06	Locker Motor
ERR07	Out Of Limit Position
ERR08	EEPROM Failure
ERR09	Over Speed
ERR10	Motor Reversion
ERR11	Overload
ERR12	Sample Current Failure
ERR13	Motor Encoder Failure
ERR14	Initial Rotor Angle Failure
ERR15	Communication Failure
ERR18	Brake Circuit Failure
ERR19	Absolute Encoder Failure
ERR20	Run Time Exceeded
ERR21	Safety1 Exceeded During Cycle
ERR22	Safety2 Exceeded During Cycle
ERR23	No Limit Settings

Port Table for 750W

Port	Function	Remark
1	PE	AC220V input
2	L	
3	N	
4	Braking resistor output +	
5	Braking resistor output -	
6	Motor brake +	
7	Motor brake -	
8	Com/Gnd	
9	Manual open input	NO
10	Manual close input	NO
11	Emergency stop input	NO
12	Manual / Automatic switch input	NO
13	DC24V+	
14	Com/Gnd	
15	Safety input 1	NO (contact infrared, airbags, etc.), stop the action
16	Safety input 2	NO (contact infrared, airbags, etc.)
17	Automatic open input	NO (contact radar, and the sense)
18	Partial open input	NO
19	Com/Gnd	
20	Start input	NO
21	Reserved	
22	Reserved	
23	Lock input	NO
24	DC24V+	
25	Com/Gnd	
26	Output 1A	1A-1B normally open, set the function selection "Output 1 Config" 1A-1B is closed
27	Output 1B	
28	Output 2A	2A-2B normally open, setting " Output 2 Config " Function selection 2A-2B is closed
29	Output 2B	
30	RS485+	
31	RS485-	

Port Table for 1500W

Port	Function	Remark
1	PE	AC220V input
2	L	
3	N	
4	Braking resistor output +	
5	Braking resistor output -	
6	Motor brake +	DC 24V
7	Motor brake -	
8	Reserved	
9	Safety input 1※	NO (Safety edge, photocell, etc.), stop
10	Safety input 2※	NO (Safety edge, photocell, etc.), reverse to open limit when closing
11	Com/Gnd	
12	DC24V+	
13	Automatic open input※	NO (Radar, sensor, etc.)
14	Partial open input※	NO (Radar, sensor, etc.)
15	Start input※	NO
16	Com/Gnd	
17	Open limit switch input※	NO
18	Close limit switch input※	NO
19	Lock input※	NO
20	Com/Gnd	
21	DC24V+	
22	Output 1A	NO, refer to "Output 1 Config"
23	Output 1B	
24	Output 2A	NO, refer to "Output 2 Config"
25	Output 2B	
26	Output 3A	NO, refer to "Output 3 Config"
27	Output 3B	
28	Output 4A	NO, refer to "Output 4 Config"
29	Output 4B	
30	RS485+	
31	RS485-	
32	Com/Gnd	
33	Open input	NO
34	Close input	NO
35	Stop input	NO
36	Emergency stop input※	NO